

## SINGLE PHASE GLASS PASSIVATED BRIDGE RECTIFIERS

### Features

- ◆ Ideal for printed circuit board
- ◆ Reliable low cost construction utilizing molded plastic technique
- ◆ High temperature soldering guaranteed: 260°/10 seconds at 5 lbs., (2.3kg) tension
- ◆ Small size, simple installation
- ◆ High surge current capability

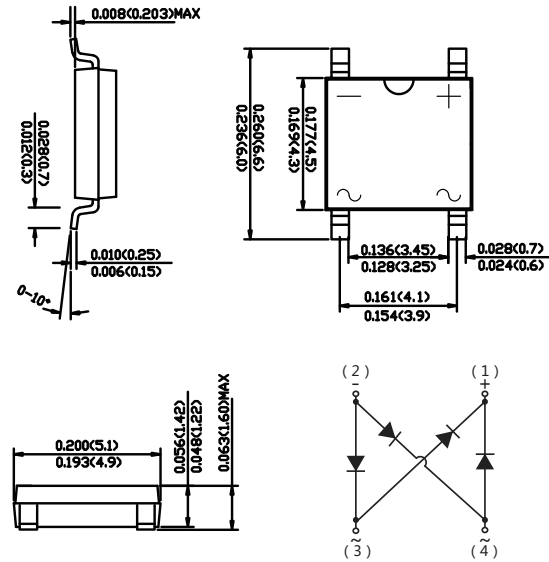

### Mechanical Data

**Case :** JEDEC ABS Molded plastic body  
**Terminals :** Solder plated, solderable per MIL-STD-750, Method 2026  
**Polarity :** Polarity symbol marking on body  
**Mounting Position :** Any

### Maximum Ratings And Electrical Characteristics

Dimensions in inches and (millimeters)

Ratings at 25°C ambient temperature unless otherwise specified.

Single phase half-wave 60Hz, resistive or inductive load, for capacitive load current derate by 20%.

Parameter	SYMBOLS	MDD	MDD	MDD	MDD	MDD	UNITS	
		AB14S	AB16S	AB18S	AB110S	AB120S		
Marking Code								
Maximum repetitive peak reverse voltage	$V_{RRM}$	40	60	80	100	200	V	
Maximum RMS voltage	$V_{RMS}$	28	42	56	70	140	V	
Maximum DC blocking voltage	$V_{DC}$	40	60	80	100	200	V	
Maximum average forward rectified current	$I_{F(AV)}$	1.0						A
Peak forward surge current, 8.3ms single half sine-wave superimposed on rated load (JEDEC Method)	$I_{FSM}$	40		30				A
Maximum instantaneous forward voltage drop per leg at 1A	$V_F$	0.55	0.70	0.85				V
Maximum DC reverse current at rated DC blocking voltage	$I_R$	$T_A=25^\circ C$ 0.3		$T_A=100^\circ C$ 0.2		0.1	mA	
Typical thermal resistance	$R_{\theta JA}$	95						°C/W
Typical junction capacitance	$C_j$	110	80					pF
Operating temperature range	$T_J$	-55 to +125						°C
storage temperature range	$T_{STG}$	-55 to +150						°C

NOTE: 1. Measured at 1MHz and applied reverse voltage of 4 V D.C.

2. Mounted on glass epoxy P C board with 4 X (5X5mm) copper pad.

## Ratings And Characteristic Curves

Fig.1 Forward Current Derating Curve

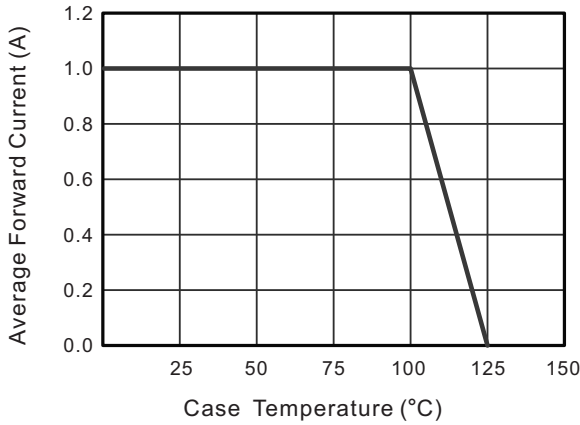

Fig.2 Typical Reverse Characteristics

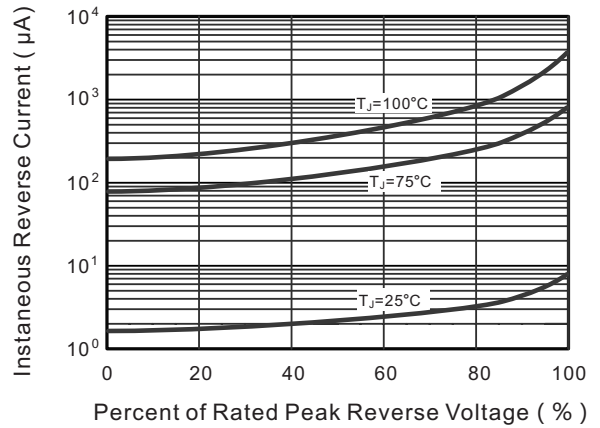

Fig.3 Typical Forward Characteristic

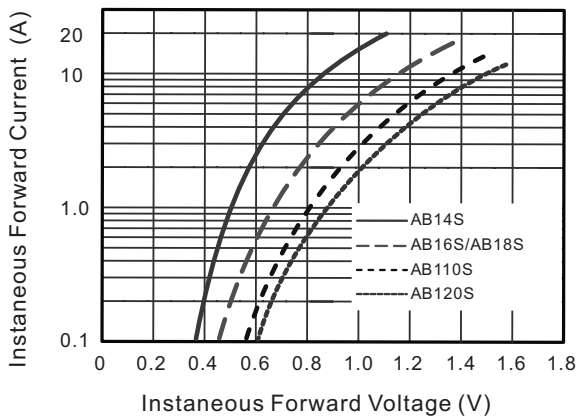

Fig.4 Typical Junction Capacitance

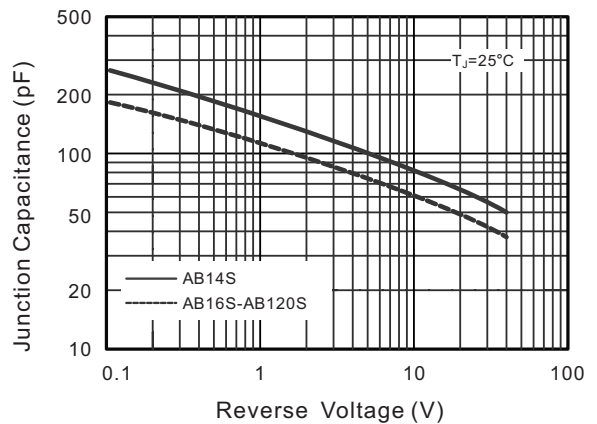

Fig.5 Maximum Non-Repetitive Peak Forward Surge Current

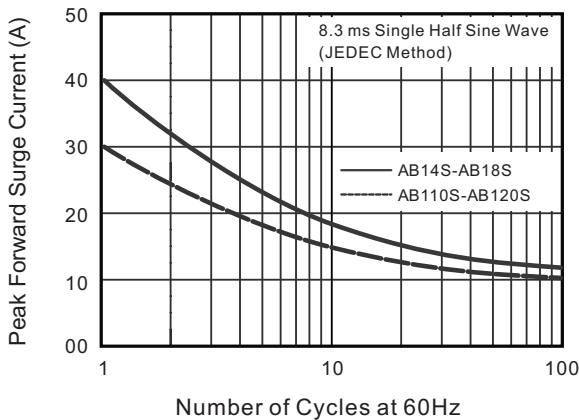
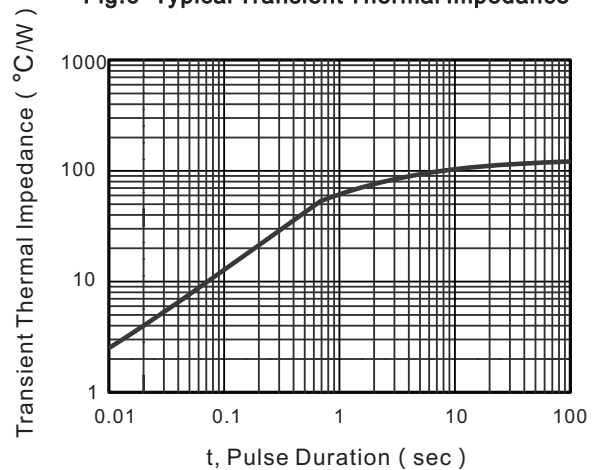
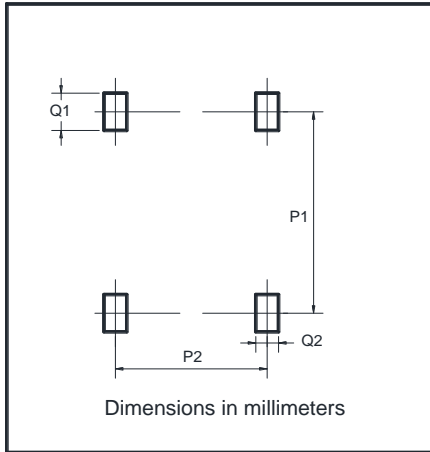

Fig.6- Typical Transient Thermal Impedance



The curve above is for reference only.

## Suggested Pad Layout



Dim	Min
P1	5.72
P2	4.00
Q1	1.00
Q2	0.90